

*jura*®



IMPRESSA C60/C65 Instructions for Use



# Your IMPRESSA C60/C65

|  |           |
|--|-----------|
| <b>Control elements</b>  | <b>4</b>  |
| <b>Important information</b>                                     | <b>6</b>  |
| Proper use .....   | 6         |
| For your safety .....  | 6         |
| <b>1 Preparing and using for the first time</b>                  | <b>10</b> |
| JURA on the Internet .....                                       | 10        |
| Setting up the machine .....                                     | 10        |
| Filling the bean container .....                                 | 10        |
| First-time use .....   | 10        |
| Determining the water hardness .....                             | 13        |
| Adjusting the grinder .....                                      | 13        |
| Filling the water tank .....                                     | 14        |
| Connecting milk .....  | 15        |
| <b>2 Preparation</b>   | <b>16</b> |
| Espresso and coffee .....  | 16        |
| Two speciality coffees at the touch of a button .....            | 17        |
| Cappuccino .....   | 17        |
| Milk foam .....  | 18        |
| Ground coffee .....  | 19        |
| Permanently setting the amount of water for the cup size .....   | 20        |
| Hot water .....  | 21        |
| <b>3 Daily operation</b>   | <b>22</b> |
| Switching on .....   | 22        |
| Daily maintenance .....  | 22        |
| Switching off .....  | 23        |
| <b>4 Permanent settings in programming mode</b>                  | <b>24</b> |
| Product settings .....   | 25        |
| Setting the water hardness .....                                 | 26        |
| Energy-saving mode .....   | 26        |
| Automatic switch-off .....                                       | 27        |
| Unit for amount of water .....                                   | 28        |
| Language .....   | 28        |
| <b>5 Maintenance</b>   | <b>29</b> |
| Rinsing the machine .....  | 29        |
| Rinsing the fine foam frother .....                              | 30        |
| Cleaning the fine foam frother .....                             | 30        |
| Dismantling and rinsing the fine foam frother .....              | 31        |
| Dismantling and rinsing the professional fine foam frother ..... | 32        |
| Inserting and activating the filter .....                        | 33        |
| Changing the filter .....  | 34        |
| Cleaning the machine .....                                       | 35        |
| Descaling the machine .....                                      | 36        |
| Cleaning the bean container .....                                | 38        |
| Descaling the water tank .....                                   | 39        |



|    |   |    |
|----|---|----|
| 6  | Display messages                                | 40 |
| 7  | Troubleshooting                                 | 42 |
| 8  | Transport and environmentally friendly disposal | 44 |
|    | Transport / Emptying the system.....            | 44 |
|    | Disposal.....                                   | 44 |
| 9  | Technical data                                  | 45 |
| 10 | Index   | 46 |
| 11 | JURA contact details / Legal information        | 48 |

## Symbol description

### Warnings

|  |   |
|--|---|
|  <b>WARNING</b> | Always take note of any information marked with the words <b>CAUTION</b> or <b>WARNING</b> and a warning sign. The signal word <b>WARNING</b> draws your attention to potential serious injury, and the signal word <b>CAUTION</b> to potential minor injury. |
|  <b>CAUTION</b> | <b>CAUTION</b> draws your attention to potential damage to the machine.   |

### Symbols used

|   |   |
|---|---|
|  | <b>Prompt to take action.</b> This symbol means that you are being prompted to perform some action. |
|  | <b>Information</b> and tips to make it even easier to use your IMPRESSA.                            |
|  | <b>Display</b>  |

Control elements

## Control elements

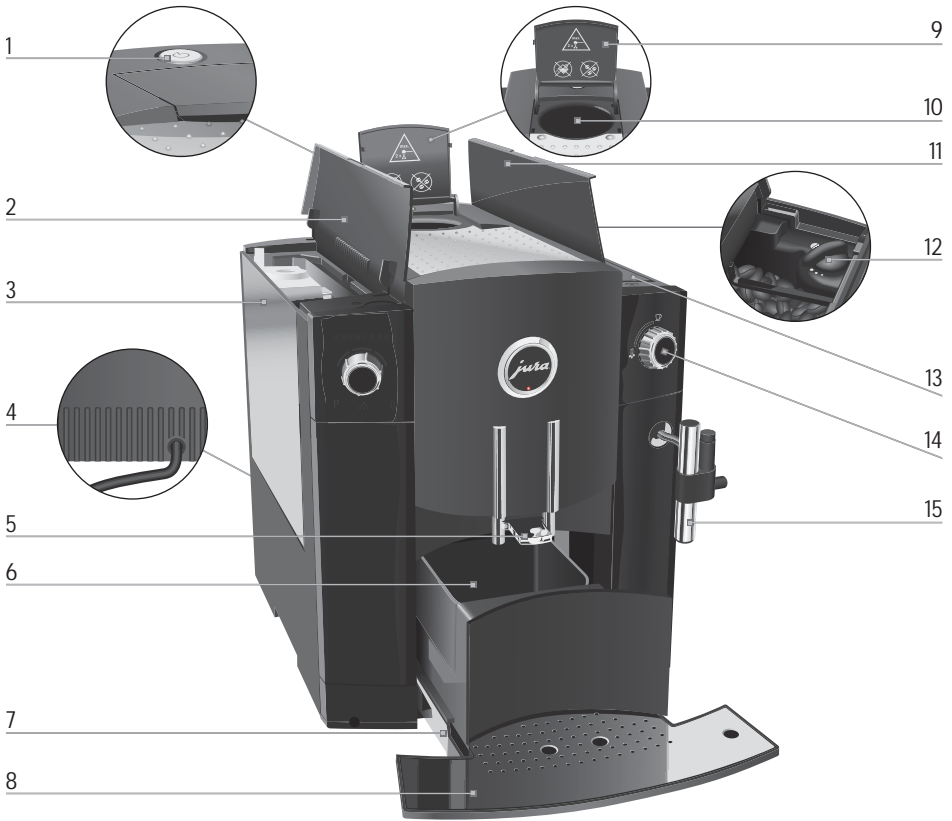

1  On/Off button

2 Water tank cover

3 Water tank

4 Mains cable (back of the machine)

5 Height-adjustable coffee spout

6 Coffee grounds container

7 Drip tray

8 Cup grille

9 Filler funnel cover

10 Filler funnel for ground coffee

11 Bean container cover

12 Grinder adjustment switch

13 Bean container with aroma preservation cover

14 Switch for hot water and steam preparation

15 Fine foam frother

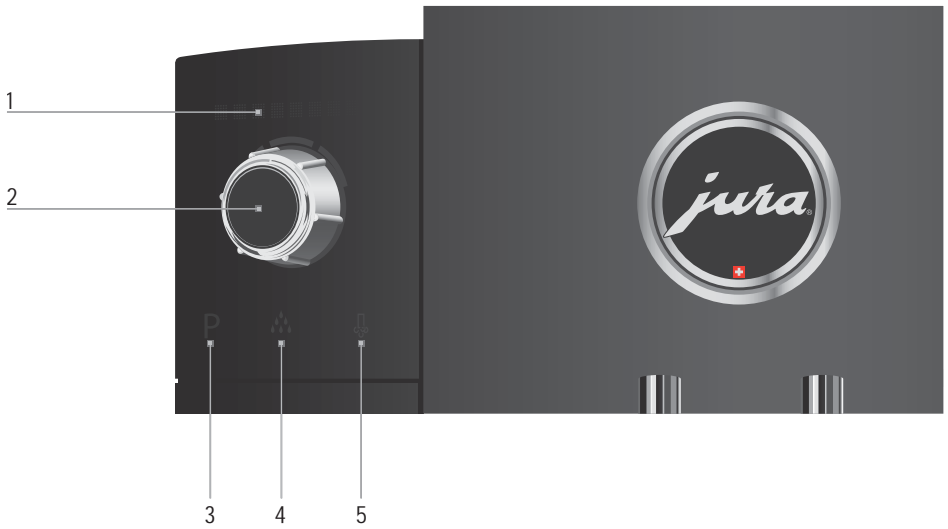

- 1 Display
- 2 Rotary Switch

- 3 P P symbol (programming)
- 4 ❄ Maintenance symbol
- 5 ⚡ Steam symbol

The Connector System® permits the use of different cappuccino frothers. These are available from stockists.

Professional fine foam frother



Milk foam  
Hot milk

Fine foam frother

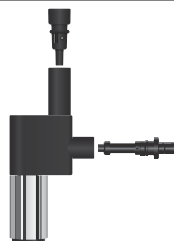

Milk foam

## Important information

### Proper use

The machine is designed and intended for private domestic use. It should only be used for coffee preparation and to heat milk and water. Use for any other purpose will be deemed improper. JURA Elektroapparate AG cannot accept any responsibility for the consequences of improper use.

Before using the machine read these instructions for use thoroughly and completely and comply with the instructions they contain. A warranty service is not applicable for damage or defects caused by non-compliance with the instructions for use. Keep these instructions for use close to the machine and pass them on to the next user.

### For your safety



Please carefully read and observe the important safety information set out below.

To avoid danger of potentially fatal electric shock:

- Never use a machine which is damaged or has a defective mains cable.
- In the event of signs of damage, for example if there is a smell of burning, unplug the machine immediately from the mains supply and contact JURA service.
- If the mains cable of this machine is damaged, it must be repaired either directly by JURA or by an authorised JURA service centre.
- Make sure that the IMPRESSA and the mains cable are not located close to hot surfaces.
- Be careful to ensure that the mains cable is not trapped and does not rub against sharp edges.

- Never open and repair the machine yourself. Do not modify the machine in any way that is not described in these instructions for use. The machine contains live parts. If opened, there is a danger of potentially fatal injury. Repairs may only be carried out by authorised JURA service centres, using original spare parts and accessories.
- To completely and safely disconnect the machine from the power supply, first switch off the IMPRESSA using the On/Off button and then at the power switch. Only then should you remove the mains plug from the power socket.

There is a risk of scalds or burns on the spouts and fine foam frother:

- Place the machine out of the reach of children.
- Do not touch any hot parts. Use the handles provided.
- Be careful to ensure that the fine foam frother is correctly installed and clean. If incorrectly fitted or if it becomes blocked, the fine foam frother or its parts might come off.

A defective machine is not safe and could cause injury or fire. To avoid damage and any associated risk of injury or fire:

- Never allow the mains cable to loosely hang down. The mains cable could pose a tripping hazard or become damaged.
- Protect the IMPRESSA from environmental influences such as rain, frost and direct sunlight.

## Important information

- Do not immerse the IMPRESSA, mains cable or connections in water.
- Do not put the IMPRESSA or any individual parts in the dishwasher.
- Switch your IMPRESSA off at the power switch before any cleaning operation. Always wipe the IMPRESSA with a damp cloth rather than a wet one, and protect it from prolonged exposure to water splash.
- Only connect the machine to the mains voltage in accordance with the information on the rating plate. The rating plate is located on the underside of your IMPRESSA. Further technical data is provided in these instructions for use (see Chapter 9 ‘Technical data’).
- Please only use original JURA maintenance products. Use of products that are not explicitly recommended by JURA could damage the IMPRESSA.
- Do not use any coffee beans treated with additives or caramelised coffee beans.
- Only fill the water tank with fresh, cold water.
- Switch the machine off at the power switch if you are going to be absent for a longer period of time.
- Children may not clean or service the machine unless supervised by a responsible person.
- Do not allow children to play with the machine.
- Keep children under the age of 8 away from the machine, or supervise them constantly.



- Children aged 8 and over may only operate the machine without supervision if they have been instructed in how to use it safely. Children must be able to recognise and understand the potential dangers arising from incorrect use.

People, including children, who

- do not have the physical, sensory or mental capabilities to use the machine safely or
- are inexperienced or lack knowledge in how to use the machine safely

must be supervised by a responsible person when using it, or must be instructed in how to use it correctly.

Safety when handling the CLARIS Blue filter cartridge:

- Filter cartridges should be kept out of the reach of children.
- Store filter cartridges in a dry place in the sealed packaging.
- Protect cartridges from heat and direct sunlight.
- Do not use damaged filter cartridges.
- Do not open filter cartridges.

# 1 Preparing and using for the first time

## JURA on the Internet

Visit us on the Internet. You can download **short operating instructions** for your machine from the JURA website ([www.jura.com](http://www.jura.com)). You will also find interesting and up-to-date information on your IMPRESSA and on every aspect of coffee.

## Setting up the machine

When setting up your IMPRESSA, please note the following:

- Place the IMPRESSA on a horizontal surface that is not sensitive to water.
- Choose a spot for your IMPRESSA which protects the machine against overheating. Ensure that the ventilation slots are not covered.

## Filling the bean container

The bean container has an aroma preservation cover. This will ensure that your coffee beans retain their aroma for longer.

### CAUTION

Coffee beans which have been treated with additives (e.g. sugar), ground coffee or freeze-dried coffee will damage the grinder.

- ▶ Only use roasted, untreated coffee beans to fill the bean container.
- 
- ▶ Open the bean container cover and remove the aroma preservation cover.
  - ▶ Remove any dirt or foreign objects from inside the bean container.
  - ▶ Fill the bean container with coffee beans, then close the aroma preservation cover and the bean container cover.

## First-time use

When using the machine for the first time, you can choose whether you want to operate IMPRESSA **with** or **without** the CLARIS Blue filter cartridge. If the water hardness is 10 °dH or more, we recommend using the filter cartridge. If you do not know the hardness of your water, you can find this out first (see Chapter 1 'Preparing and using for the first time – Determining the water hardness').

**⚠ WARNING**

If the machine is operated with a defective mains cable, there is a danger of potentially fatal electric shock.

- ▶ Never use a machine which is damaged or has a defective mains cable.

**Precondition:** The bean container has been filled.

- ▶ Insert the mains plug into a power socket.
- ⏻ ▶ Press the On/Off button to switch the IMPRESSA on.  
**SPRACHE DE** appears on the display.
- ⌚ ▶ Turn the Rotary Switch until the required language is displayed, e.g. **LANGUAGE EN**.
- ⏻ ▶ Press the Rotary Switch to confirm the language.  
**OK** appears briefly on the display to confirm the setting.  
**FILTER ✓ / YES**
- i** Now decide whether you want to operate your IMPRESSA **with** or **without** a CLARIS Blue filter cartridge.

### First-time use with filter cartridge activation

- ⌚ ▶ Press the Rotary Switch.  
**OK** appears briefly on the display.  
**FILTER INSERT**, the Maintenance symbol **⚠** lights up.
- ⚠** ▶ Touch the Maintenance symbol.  
**FILL TANK**
- ▶ Open the water tank cover.
- ▶ Remove the water tank and rinse it with cold water.
- ▶ Open the filter holder.
- ▶ Remove the CLARIS Blue filter cartridge from the Welcome Pack.
- ▶ Insert the CLARIS Blue filter cartridge into the water tank, exerting slight pressure.
- ▶ Close the filter holder. It will click into place audibly.
- i** After two months, the filter will cease to work. Set the date on the date plate on the filter holder in the water tank.
- ▶ Fill the water tank with fresh, cold water and reinsert the tank.



## 1 Preparing and using for the first time

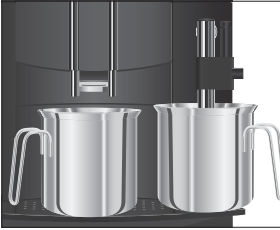

**SWITCH OPEN**, the light segment on the switch lights up.

- ▶ Place one receptacle under the coffee spout and another under the fine foam frother.



- ▶ Turn the switch to the  position.

**FILTER RINSING**, water flows out of the fine foam frother.



You can interrupt rinsing of the filter at any time. To do this, turn the switch clockwise. Turn the switch anticlockwise to continue rinsing the filter.



The water may be slightly discoloured. This is not harmful to health and does not affect the taste.

Rinsing of the filter stops automatically after approximately 500 ml. **SWITCH CLOSE** appears on the display.



- ▶ Turn the switch to the  position.

**SYSTEM FILLING**, the system fills up with water.

**HEATING**, the machine heats up.

**RINSING**, the system is rinsed. Water flows out of the coffee spout. The rinse stops automatically. **ESPRESSO** appears on the display. Your IMPRESSA is ready for use.

### First-time use without filter cartridge activation



- ▶ Turn the Rotary Switch until **FILTER -- / NO** is displayed.



- ▶ Press the Rotary Switch.

**OK** appears briefly on the display.

**16 °dH**



If you do not know the hardness of your water, you must find this out first (see Chapter 1 'Preparing and using for the first time – Determining the water hardness').



- ▶ Turn the Rotary Switch to change the water hardness setting, e.g. to **25 °dH**.



- ▶ Press the Rotary Switch.

**OK** appears briefly on the display.

**FILL TANK**

- ▶ Open the water tank cover.

- ▶ Remove the water tank and rinse it with cold water.



- ▶ Fill the water tank with fresh, cold water and reinsert the tank.
- ▶ **SWITCH OPEN**, the light segment on the switch lights up.
- ▶ Place one receptacle under the coffee spout and another under the fine foam frother.
- ▶ Turn the switch to the ☘ position.
- ▶ **SYSTEM FILLING**, the system fills up with water.
- ▶ **SWITCH CLOSE**
- ▶ Turn the switch to the ☐ position.
- ▶ **SYSTEM FILLING**, the system fills up with water.
- ▶ **HEATING**, the machine heats up.
- ▶ **RINSING**, the system is rinsed. Water flows out of the coffee spout. The rinse stops automatically. **ESPRESSO** appears on the display. Your IMPRESSA is ready for use.

## Determining the water hardness

You can find out what the water hardness is by using the Aquadur® test strip supplied as standard.

- ▶ Hold the test strip briefly (for 1 second) under flowing water. Shake off the water.
- ▶ Wait for about 1 minute.
- ▶ You will then be able to read the degree of water hardness from the discolouration of the Aquadur® test strip and the description on the packaging.

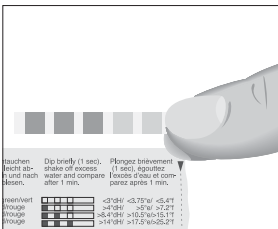

## Adjusting the grinder

You can adjust the grinder on a continuous scale to suit the degree of roast of your coffee.

### CAUTION

If you adjust the consistency of grind when the grinder is not operating, the grinder adjustment switch could be damaged.

- ▶ Only adjust the consistency of grind when the grinder is running.

The consistency of grind is correct if the coffee flows regularly from the coffee spout. In addition a fine, thick crema forms.

## 1 Preparing and using for the first time

**Example:** Proceed as follows to change the consistency of grind **during** the preparation of an espresso.

- ▶ Place a cup under the coffee spout.
- ▶ Open the bean container cover and remove the aroma preservation cover.
- ▶  Press the Rotary Switch to start preparation.
- ▶ Turn the grinder adjustment switch to the desired position **while** the grinder is running.  
The preset amount of water flows into the cup. Preparation stops automatically.
- ▶ Fit the aroma preservation cover.
- ▶ Close the bean container cover.

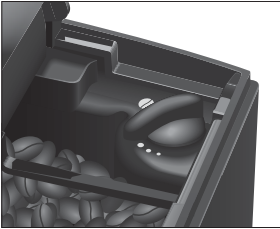

## Filling the water tank

Daily maintenance of the machine and hygiene when handling milk, coffee and water are key to a perfect coffee result in the cup every time. You should therefore change the water **daily**.

### CAUTION

Milk, sparkling mineral water or other liquids can damage the water tank or the machine.

- ▶ Only fill the water tank with fresh, cold water.

- ▶ Open the water tank cover.
- ▶ Remove the water tank and rinse it with cold water.
- ▶ Fill the water tank with fresh, cold water and reinsert the tank.
- ▶ Close the water tank cover.



## Connecting milk

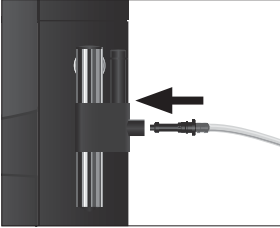

Your IMPRESSA creates fine, creamy, feather-light milk foam with a perfect consistency. The most important requirement for frothing milk is a milk temperature of 4–8 °C. We would therefore recommend using a milk cooler or a vacuum milk container.

- ▶ Remove the protective cover from the fine foam frother.
- ▶ Connect the milk pipe to the fine foam frother. To do this, attach the end of the milk pipe to the connector on the right-hand side of the fine foam frother. Use the short pipe for a milk container and the long pipe for a milk carton.



- ▶ Connect the other end of the milk pipe to a milk container or immerse it in a milk carton. (Figure: JURA 0.4 litre stainless steel vacuum milk container).

## 2 Preparation

- i** You can stop the machine at any time while a speciality coffee, steam or hot water is being prepared. Just press the Rotary Switch (for a speciality coffee) or return the switch to its original position (for steam and hot water).
- i** During the grinding operation you can select the coffee strength of **single products** by turning the Rotary Switch : **MILD, NORMAL, STRONG** or **EXTRA**.
- i** During preparation, you can change the preset **amount of water** for a speciality coffee by turning the Rotary Switch .
- i** You can follow the current status of preparation on the progress bar.
- i** The last speciality coffee prepared is always displayed, even if the IMPRESSA was switched off in the meantime.

Coffee tastes best served hot. A cold porcelain cup cools the beverage – and impairs the taste. We therefore recommend prewarming the cups. The full coffee aroma can develop only in prewarmed cups. You can purchase a JURA cup warmer from your specialised dealer.



You can make **permanent settings** for all products in programming mode (see Chapter 4 ‘Permanent settings in programming mode – Product settings’).

### Espresso and coffee

Espresso and coffee are both prepared following this model.

**Example:** Proceed as follows to prepare one coffee.

**Precondition:** **ESPRESSO** is displayed (example).

- ▶ Place a cup under the coffee spout.
-  ▶ Turn the Rotary Switch until **COFFEE** is displayed.
-  ▶ Press the Rotary Switch.

Preparation starts. **COFFEE** and the coffee strength are displayed. The preset amount of water for coffee flows into the cup.

Preparation stops automatically. **COFFEE** appears on the display.





## Two speciality coffees at the touch of a button



When you prepare two drinks at once, the amount of water selected for the single product is used for each cup.

The preparation of two espressi and two coffees follows this same model.

**Example:** Proceed as follows to prepare two espressi.

**Precondition:** **ESPRESSO** is displayed (example).

- ▶ Place two espresso cups under the coffee spout.
- ▶ Press the Rotary Switch twice (**within 2 seconds**), to start preparation of two espressi.

**2 CUPS**

Preparation starts. The preset amount of water flows into the cups.

Preparation stops automatically. **ESPRESSO** appears on the display (example).

## Cappuccino

For a cappuccino you must first froth the milk using the fine foam frother. You then prepare an espresso straight into the milk foam.

- i** This chapter applies to the **professional fine foam frother** and the **fine foam frother**.

**Precondition:** **ESPRESSO** is displayed (example). Milk is connected to the fine foam frother.

- ▶ Place a cup under the fine foam frother.

- i** If you are using the **professional fine foam frother**, turn the selector switch to the Milk Foam position .

- ▶ Touch the Steam symbol.

**HEATING / STEAM**

As soon as the machine has heated up, **STEAM / READY** appears, the light segment on the switch lights up.

- ▶ Turn the switch to the  position.



**STEAM** appears and the milk foam is prepared.

- ▶ When the cup is about two thirds full of milk foam, turn the switch to the  position.

**STEAM / READY**



## 2 Preparation

- i** You can continue to prepare steam for the next 40 seconds or so without the machine having to heat up again.
- i** Touch the Steam symbol . **ESPRESSO** appears on the display (example). Now you can prepare speciality coffees again.
  - ▶ Place the cup under the coffee spout.
-  ▶ Press the Rotary Switch.
  - Coffee preparation starts. The preset amount of water for espresso flows into the cup.
  - Preparation stops automatically. **ESPRESSO** appears on the display.

To ensure that the fine foam frother always works properly, you must clean it **daily** when you have been preparing milk (see Chapter 5 ‘Maintenance – Cleaning the fine foam frother’). Your IMPRESSA will **not** prompt you to clean the fine foam frother.

## Milk foam

- i** This chapter applies to the **professional fine foam frother** and the **fine foam frother**.
- i** With the professional fine foam frother, available as an optional accessory, you can also prepare hot milk.

**Example:** Proceed as follows to prepare milk foam.

**Precondition:** **ESPRESSO** is displayed (example). Milk is connected to the fine foam frother.

- ▶ Place a cup under the fine foam frother.

- i** If you are using the **professional fine foam frother**, turn the selector switch to the Milk Foam position .



-  ▶ Touch the Steam symbol.

**HEATING / STEAM**

As soon as the machine has heated up, **STEAM / READY** appears, the light segment on the switch lights up.

-  ▶ Turn the switch to the  position.

**STEAM** appears and the milk foam is prepared.

-  ▶ When there is enough milk foam in the cup, turn the switch back to the  position.

**STEAM / READY**



- i** You can continue to prepare steam for the next 40 seconds or so without the machine having to heat up again.

To ensure that the fine foam frother always works properly, you must clean it **daily** when you have been preparing milk (see Chapter 5 'Maintenance – Cleaning the fine foam frother'). Your IMPRESSA will **not** prompt you to clean the fine foam frother.

## Ground coffee



You can choose to use a second coffee variety, for example decaffeinated coffee, with the filter funnel for ground coffee.

- i** Never add more than two level measuring spoons of ground coffee.
- i** Use ground coffee which is not ground too finely. Very fine coffee can block up the system so that the coffee only comes out in drips.
- i** If you did not fill the machine with a sufficient amount of ground coffee, **LOW FILL GROUND C** is displayed and the IMPRESSA stops the operation.
- i** The desired speciality coffee must be prepared within approximately one minute after filling with the ground coffee. Otherwise the IMPRESSA stops the operation and is once more ready for use.

All speciality coffees with ground coffee are prepared following this model.

**Example:** Proceed as follows to prepare a coffee using ground coffee.

**Precondition:** **ESPRESSO** is displayed (example).

- ▶ Place a cup under the coffee spout.
-  ▶ Turn the Rotary Switch until **GROUND C** is displayed.
-  ▶ Press the Rotary Switch.

**FILL GROUND C**

## 2 Preparation



- ▶ Open the cover of the filler funnel for ground coffee.
- ▶ Place one level measuring spoon of ground coffee into the filler funnel.

▶ Close the cover of the filler funnel.



▶ Press the Rotary Switch.

**ESPRESSO** (example)



▶ Turn the Rotary Switch until **COFFEE** is displayed.



▶ Press the Rotary Switch.

Preparation starts. **COFFEE**, the preset amount of water for coffee flows into the cup.

Preparation stops automatically. **COFFEE** appears on the display.

### Permanently setting the amount of water for the cup size

It is easy to make permanent settings for the amount of water for all speciality coffees according to the cup size. Adjust the amount once as shown in the following example. Every time you prepare a drink in the future, this amount of water will be dispensed.

The process for permanently adapting the amount of water to the cup size is the same for all speciality coffees.

**Example:** Proceed as follows to **permanently** set the amount of water for one coffee.

**Precondition:** **ESPRESSO** is displayed (example).

▶ Place a cup under the coffee spout.



▶ Turn the Rotary Switch until **COFFEE** is displayed.



▶ Press and **hold** the Rotary Switch.

**COFFEE**



▶ Continue to **hold** the Rotary Switch until **ENOUGH COFFEE ?** appears.



▶ Release the Rotary Switch.

Preparation starts and the coffee flows into the cup.



▶ As soon as there is sufficient coffee in the cup, press the Rotary Switch.

Preparation stops. **OK** appears briefly on the display. The set amount of water for one coffee is permanently stored.

**COFFEE** appears on the display.



- i** You can alter this setting at any time by repeating the above procedure.
- i** You can also permanently set the amount of water for all speciality coffees in programming mode (see Chapter 4 'Permanent settings in programming mode – Product settings').

## Hot water

### **⚠ CAUTION**

There is a danger of scalding from hot water splashes.

- ▶ Avoid direct contact with the skin.

**Example:** Proceed as follows to prepare hot water.

**Precondition:** **ESPRESSO** is displayed (example).



- ▶ Place a cup under the fine foam frother.
- ⊗** ▶ Turn the switch to the **☘** position.  
**WATER**, water flows out of the fine foam frother.
- ⊗** ▶ When there is enough water in the cup, turn the switch back to the **☘** position.  
**ESPRESSO** appears on the display (example).

## 3 Daily operation

### Switching on



Daily maintenance of the machine and hygiene when handling milk, coffee and water are key to a perfect coffee result in the cup every time. You should therefore change the water **daily**.

- ▶ Place a receptacle under the coffee spout.
- ▶ Press the On/Off button to switch the IMPRESSA on.

**HEATING**

**RINSING**, the system is rinsed. The rinse stops automatically. **ESPRESSO** appears on the display (example). Your IMPRESSA is ready for use.

### Daily maintenance

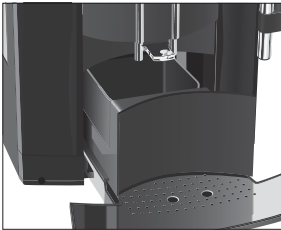

To ensure that you get many years of reliable service out of your IMPRESSA and to guarantee the optimum coffee quality, the machine requires daily maintenance.

- ▶ Pull out the drip tray.
- ▶ Empty the coffee grounds container and the drip tray. Rinse them both with warm water.

**i** Always empty the coffee grounds container when the machine is **switched on**. This is the only way of resetting the coffee grounds counter to zero.

**i** E Traces of milk and coffee may stick to the top and bottom of the cup grille. Clean the cup grille regularly.

- ▶ Refit the coffee grounds container and the drip tray.
- ▶ Rinse the water tank with clean water.

**i** Clean the insides of the water tank regularly (e.g. with a brush) to prevent deposits building up.

- ▶ Clean the fine foam frother (see Chapter 5 'Maintenance – Cleaning the fine foam frother').
- ▶ Dismantle and rinse the fine foam frother (see Chapter 5 'Maintenance – Dismantling and rinsing the fine foam frother').
- ▶ Wipe the surface of the machine with a clean, soft, damp cloth (e.g. microfibre cloth).

- i** In the interests of hygiene, we recommend changing the milk pipe on a regular basis (approx. every 3 months). Replacement pipes are available from specialised dealers.

## Switching off

When the IMPRESSA is switched off, the system is automatically rinsed if a speciality coffee has been prepared.

**Precondition:** **ESPRESSO** is displayed (example).



- ▶ Place a receptacle under the coffee spout.
- ⏻ ▶ Press the On/Off button.
- ▶ **RINSING**, the system is rinsed. The operation stops automatically. Your IMPRESSA is switched off.
- i** When the IMPRESSA is switched off with the On/Off button, the machine consumes less than 0.01 W of standby energy.

## 4 Permanent settings in programming mode

You can make permanent settings in programming mode. You can navigate through the programme items and permanently save the required settings simply by turning and pressing the Rotary Switch. You can make the following settings with the Rotary Switch:

| Programme item                                | Sub-item   | Explanation  |
|---|--|--|
| RINSE   | RINSE,<br>CLEAN,<br>FILTER (only if filter<br>is activated),<br>DESCALE (only if<br>filter is not activated) | ▶ Select the desired maintenance programme.  |
| BUTTONS                                       |  | ▶ Select your settings for speciality coffees.   |
| FILTER ✓ /<br>FILTER –                        | YES,<br>NO   | ▶ Indicate whether you are operating your IMPRESSA with or without a CLARIS Blue filter cartridge. |
| HARDNESS (only if<br>filter is not activated) | 1 °dH – 30 °dH   | ▶ Adjust the water hardness.   |
| ENERGY ✓ /<br>ENERGY –                        | SAVE ✓,<br>SAVE –  | ▶ Choose whether you want to operate your IMPRESSA with or without energy-saving mode.             |
| OFF FROM                                      | 15 MIN., 30 MIN.,<br>1 HRS. – 15 HRS.  | ▶ Set the time after which the IMPRESSA should switch off automatically.                           |
| DISPLAY                                       | ML, OZ   | ▶ Select the unit for the amount of water.   |
| LANGUAGE                                      |  | ▶ Select your language.  |
| EXIT  |  | ▶ Exit programming mode.   |

**i** You can exit programming mode directly at any time. Simply touch the P symbol for approximately 2 seconds.



## Product settings











In the programme item **BUTTONS** you can make individual settings for espresso and coffee. The following permanent settings can be made:

| Product          | Amount  | Coffee strength             | Temperature  |
|------------------|---|-----------------------------|--------------|
| Espresso, coffee | Volume:<br>25 ML – 240 ML   | MILD, NORMAL, STRONG, EXTRA | NORMAL, HIGH |
| 2 cups           | When you prepare two drinks at once, the temperature and amount of water selected for the single product are used for each cup. |                             |              |

Permanent settings in programming mode always follow the same model.

**Example:** Proceed as follows to change the coffee strength for one coffee from **NORMAL** to **STRONG**.

**Precondition:** **ESPRESSO** is displayed (example).

- P** ▶ Touch the P symbol for **approximately 2 seconds** until **RINSE** appears on the display.
-  ▶ Turn the Rotary Switch until **BUTTONS** is displayed.
-  ▶ Press the Rotary Switch to enter the programme item.  
**ESPRESSO**
-  ▶ Turn the Rotary Switch until **COFFEE** is displayed.
-  ▶ Press the Rotary Switch.  
**VOLUME**
-  ▶ Turn the Rotary Switch until **STRENGTH** is displayed.
-  ▶ Press the Rotary Switch to enter the programme item.  
**NORMAL**
-  ▶ Turn the Rotary Switch until **STRONG** is displayed.
-  ▶ Press the Rotary Switch to confirm the setting.  
**OK** appears briefly on the display.  
**STRENGTH**
-  ▶ Turn the Rotary Switch until **EXIT** is displayed.
-  ▶ Press the Rotary Switch to exit the programme item.  
**ESPRESSO**
- P** ▶ Touch the P symbol to exit programming mode.  
**ESPRESSO** (example)

## Setting the water hardness





The harder the water is, the more frequently the IMPRESSA needs to be descaled. It is therefore important to set the water hardness accurately.

The water hardness can be adjusted on a continuous scale between 1 °dH and 30 °dH.

- i** If you are using the CLARIS Blue filter cartridge and have activated it, it is not possible to set the water hardness.

**Example:** Proceed as follows to change the water hardness setting from 16 °dH to 25 °dH.

**Precondition:** ESPRESSO is displayed (example).

- P** ▶ Touch the P symbol for **approximately 2 seconds** until RINSE appears on the display.
-  ▶ Turn the Rotary Switch until HARDNESS is displayed.
-  ▶ Press the Rotary Switch to enter the programme item.  
16 °dH
-  ▶ Turn the Rotary Switch until 25 °dH is displayed.
-  ▶ Press the Rotary Switch to confirm the setting.  
OK appears briefly on the display.  
HARDNESS
- P** ▶ Touch the P symbol to exit programming mode.  
ESPRESSO (example)





## Energy-saving mode

The energy-saving mode (Energy Save Mode, E.S.M.®) helps you to prevent your machine from consuming power unnecessarily and to actively save energy:

- ENERGY ✓
  - Soon after the last preparation, the IMPRESSA stops heating up. After about 5 minutes the message ENERGY ✓ is displayed.
  - Before you can prepare a speciality coffee, steam or hot water, the machine must heat up.
- ENERGY —
  - All speciality coffees as well as hot water can be prepared without having to wait.
  - Before you can prepare steam, the machine must heat up.

**Example:** Proceed as follows to change the energy-saving mode from **ENERGY ✓** to **ENERGY –**.

**Precondition:** **ESPRESSO** is displayed (example).

- P** ▶ Touch the P symbol for **approximately 2 seconds** until **RINSE** appears on the display.
-  ▶ Turn the Rotary Switch until **ENERGY ✓** is displayed.
-  ▶ Press the Rotary Switch to enter the programme item.  
**SAVE ✓**
-  ▶ Turn the Rotary Switch until **SAVE –** is displayed.
-  ▶ Press the Rotary Switch to confirm the setting.  
**OK** appears briefly on the display.  
**ENERGY –**
- P** ▶ Touch the P symbol to exit programming mode.  
**ESPRESSO** (example)





## Automatic switch-off

By instructing your IMPRESSA to automatically switch itself off, you can cut down your energy consumption. If this function is activated, your IMPRESSA switches off automatically after the preset time following the last action on the machine.

You can set the automatic switch-off to 15 minutes, 30 minutes or 1–15 hours.

**Example:** Proceed as follows to change the switch-off time from **2 HRS.** to **1 HRS.**.

**Precondition:** **ESPRESSO** is displayed (example).





- P** ▶ Touch the P symbol for **approximately 2 seconds** until **RINSE** appears on the display.
-  ▶ Turn the Rotary Switch until **OFF FROM** is displayed.
-  ▶ Press the Rotary Switch to enter the programme item.  
**2 HRS.**
-  ▶ Turn the Rotary Switch until **1 HRS.** is displayed.
-  ▶ Press the Rotary Switch to confirm the setting.  
**OK** appears briefly on the display.  
**OFF FROM**
- P** ▶ Touch the P symbol to exit programming mode.  
**ESPRESSO** (example)

## Unit for amount of water

In the programme item **DISPLAY** you can select the unit used for the amount of water.

**Example:** Proceed as follows to change the unit for the amount of water from **ML** to **OZ**.

**Precondition:** **ESPRESSO** is displayed (example).





- P** ▶ Touch the P symbol for **approximately 2 seconds** until **RINSE** appears on the display.
-  ▶ Turn the Rotary Switch until **DISPLAY** is displayed.
-  ▶ Press the Rotary Switch to enter the programme item.  
**ML**
-  ▶ Turn the Rotary Switch until **OZ** is displayed.
-  ▶ Press the Rotary Switch to confirm the setting.  
**OK** appears briefly on the display.  
**DISPLAY**
- P** ▶ Touch the P symbol to exit programming mode.  
**ESPRESSO** (example)

## Language

In the programme item **LANGUAGE** you can select the language used by your IMPRESSA.

**Example:** Proceed as follows to change the language from **EN** to **DE**.

**Precondition:** **ESPRESSO** is displayed (example).

- P** ▶ Touch the P symbol for **approximately 2 seconds** until **RINSE** appears on the display.
-  ▶ Turn the Rotary Switch until **LANGUAGE** is displayed.
-  ▶ Press the Rotary Switch to enter the programme item.  
**EN**
-  ▶ Turn the Rotary Switch until **DE** is displayed.
-  ▶ Press the Rotary Switch to confirm the setting.  
**OK** appears briefly on the display.  
**SPRACHE**
- P** ▶ Touch the P symbol to exit programming mode.  
**ESPRESSO** (example)

## 5 Maintenance

Your IMPRESSA has the following integrated maintenance programmes:

- Rinsing the machine (**RINSE**)
- Cleaning the machine (**CLEAN**)
- Changing the filter (**FILTER**) (only if filter is activated)
- Descaling the machine (**DESCALE**) (only if filter is not activated)

**i** Clean the machine, change the filter or descale the machine when you are prompted to do so.

**i** You can start the maintenance programmes at any time in programming mode (programme item **RINSE**).

**i** Your IMPRESSA will not prompt you to clean the fine foam frother. In the interests of hygiene, you should clean the fine foam frother **daily** when you have been preparing milk.

### Rinsing the machine





You can initiate the rinse operation manually at any time.

**Precondition:** **ESPRESSO** is displayed (example).

- ▶ Place a receptacle under the coffee spout.

**P** ▶ Touch the P symbol for **approximately 2 seconds** until **RINSE** appears on the display.

 ▶ Press the Rotary Switch to enter the programme item. **RINSE**

 ▶ Press the Rotary Switch to initiate the rinse operation. **RINSING**, water flows out of the coffee spout.

The rinse stops automatically. **ESPRESSO** appears on the display (example).

## Rinsing the fine foam frother



**i** This chapter applies to the **professional fine foam frother** and the **fine foam frother**.

To ensure that the fine foam frother always works properly, you must rinse it with water **after every** milk preparation.

Your IMPRESSA will **not** prompt you to rinse the fine foam frother.

**Precondition:** **ESPRESSO** is displayed (example).

- ▶ Remove the milk pipe from the milk container or carton.
- ▶ Fill a receptacle with 250 ml of fresh water.
- ▶ Immerse the milk pipe in the receptacle.
- ▶ Place a receptacle under the fine foam frother.

⏏ ▶ Touch the Steam symbol.

**HEATING / STEAM**

As soon as the machine has heated up, **STEAM / READY** appears, the light segment on the switch lights up.

⊕ ▶ Turn the switch to the ⊕ position.

**STEAM** appears and the fine foam frother and the milk pipe are rinsed with fresh water.

⊕ ▶ When clean water starts to flow out of the frother, turn the switch back to the ⊕ position.

**STEAM / READY**

The rinsing of the fine foam frother is now complete.

## Cleaning the fine foam frother

**i** This chapter applies to the **professional fine foam frother** and the **fine foam frother**.

To ensure that the fine foam frother always works properly, you must clean it **daily** when you have been preparing milk. Your IMPRESSA will **not** prompt you to clean the fine foam frother.

### CAUTION

If the wrong cleaning agent is used, the machine could be damaged and/or traces could be left behind in the water.

- ▶ Use only original JURA maintenance products.

**i** JURA milk system cleaner is available from specialised dealers.

**Precondition:** ESPRESSO is displayed (example).



- ▶ Remove the milk pipe from the milk container or carton.
- ▶ Pour 250 ml of fresh water into a receptacle and add one capful of milk system cleaner.
- ▶ Immerse the milk pipe in the receptacle.
- ▶ Place a receptacle under the fine foam frother.



- ▶ Touch the Steam symbol.

HEATING / STEAM

As soon as the machine has heated up, STEAM / READY appears, the light segment on the switch lights up.



- ▶ Turn the switch to the ⚡ position.

STEAM appears and the fine foam frother and the milk pipe are cleaned.



- ▶ As soon as the receptacle containing the cleaning solution is empty, turn the switch to the ☞ position.

STEAM / READY

- ▶ Rinse the receptacle thoroughly, fill it with 250 ml of fresh water and immerse the milk pipe in the water.
- ▶ Empty the other receptacle and place it under the fine foam frother once more.



- ▶ Turn the switch to the ⚡ position.

STEAM, the fine foam frother and the milk pipe are rinsed with fresh water.



- ▶ As soon as the receptacle containing the fresh water is empty, turn the switch to the ☞ position.

STEAM / READY

The cleaning of the fine foam frother is now complete.

## Dismantling and rinsing the fine foam frother

To make sure the fine foam frother works properly, and in the interests of hygiene, it must be dismantled and rinsed **daily** if you have been preparing milk. Your IMPRESSA will not prompt you to dismantle and rinse the frother.

- ▶ Remove the milk pipe and rinse it thoroughly under running water.
- ▶ Carefully remove the fine foam frother from the Connector System® by twisting slightly.

## 5 Maintenance

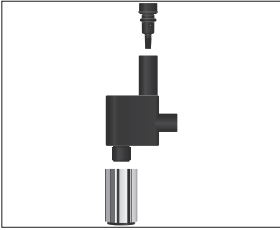

- ▶ Dismantle the fine foam frother into its individual parts.
- ▶ Rinse all the parts of the fine foam frother thoroughly under running water. If there are severely dried-on milk residues, firstly immerse the individual parts in JURA milk system cleaner and then rinse them thoroughly.
- ▶ Re-assemble the fine foam frother.

**i** Ensure that all individual parts are correctly and firmly connected to ensure optimum operation.

- ▶ Firmly attach the fine foam frother to the Connector System®.

### Dismantling and rinsing the professional fine foam frother

To make sure the professional fine foam frother works properly, and in the interests of hygiene, it must be dismantled and rinsed **daily** if you have been preparing milk. Your IMPRESSA will not prompt you to dismantle and rinse the frother.

- ▶ Remove the milk pipe and rinse it thoroughly under running water.
- ▶ Carefully remove the professional fine foam frother from the Connector System® by twisting slightly.
- ▶ Dismantle the professional fine foam frother into its individual parts.
- ▶ Rinse all the parts of the professional fine foam frother thoroughly under running water. If there are severely dried-on milk residues, firstly immerse the individual parts in JURA milk system cleaner and then rinse them thoroughly.
- ▶ Re-assemble the professional fine foam frother.



**i** Ensure that all individual parts are correctly and firmly connected to ensure optimum operation.

- ▶ Firmly attach the professional fine foam frother to the Connector System®.



## Inserting and activating the filter

Your IMPRESSA no longer has to be descaled if you are using the CLARIS Blue filter cartridge. If you did not activate the filter cartridge the first time you used the machine, you can do this now as follows.

- i** Perform the ‘inserting the filter’ operation without any interruptions. This will ensure that your IMPRESSA always produces its best.

**Precondition:** **ESPRESSO** is displayed (example).

- P** ▶ Touch the P symbol for **approximately 2 seconds** until **RINSE** appears on the display.

-  ▶ Turn the Rotary Switch until **FILTER** — is displayed.

-  ▶ Press the Rotary Switch to enter the programme item. **NO**

-  ▶ Turn the Rotary Switch until **YES** is displayed.

-  ▶ Press the Rotary Switch to confirm the setting.

**OK** appears briefly on the display.

**FILTER INSERT**, the Maintenance symbol  lights up.

- ▶ Remove and empty the water tank.

- ▶ Open the filter holder.

- ▶ Remove the CLARIS Blue filter cartridge from the Welcome Pack.

- ▶ Insert the CLARIS Blue filter cartridge into the water tank, exerting slight pressure.

- ▶ Close the filter holder. It will click into place audibly.

- i** After two months, the filter will cease to work. Set the date on the date plate on the filter holder in the water tank.

- ▶ Fill the water tank with fresh, cold water and reinsert the tank.

- ▶ Place a receptacle (at least 500 ml) under the fine foam frother.

-  ▶ Touch the Maintenance symbol.

**SWITCH OPEN**, the light segment on the switch lights up.

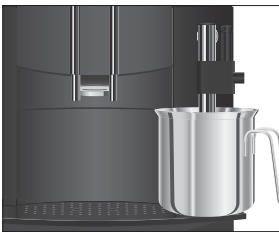

-  ▶ Turn the switch to the  position.

**FILTER RINSING**, water flows out of the fine foam frother.



- i** You can interrupt rinsing of the filter at any time. To do this, turn the switch clockwise. Turn the switch anticlockwise to continue rinsing the filter.
- i** The water may be slightly discoloured. This is not harmful to health and does not affect the taste.

Rinsing of the filter stops automatically after approximately 500 ml. **SWITCH CLOSE** appears on the display.

-  ▶ Turn the switch to the  position. **HEATING**, the machine heats up. **ESPRESSO** appears on the display (example). The filter is now activated.

## Changing the filter

- i** After 50 litres of water have flowed through, the filter will cease to work. Your IMPRESSA will automatically prompt you to change the filter.
- i** After two months, the filter will cease to work. Set the date on the date plate on the filter holder in the water tank.
- i** If the CLARIS Blue filter cartridge is not activated in programming mode, you will not be prompted to change the filter.
- i** CLARIS filter cartridges are available from specialised dealers.

**Precondition:** **FILTER / ESPRESSO** is displayed (example).

-  ▶ Touch the Maintenance symbol for **approximately 2 seconds**. **FILTER CHANGE** appears on the display.
- ▶ Remove and empty the water tank.
- ▶ Open the filter holder and remove the old CLARIS Blue filter cartridge.
- ▶ Insert a **new** CLARIS filter cartridge Blue into the water tank, exerting slight pressure.
- ▶ Close the filter holder. It will click into place audibly.
- ▶ Fill the water tank with fresh, cold water and reinsert the tank.



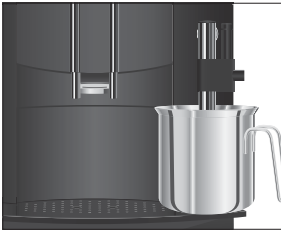

- ▶ Place a receptacle (at least 500 ml) under the fine foam frother.
- ⚠ ▶ Touch the Maintenance symbol.  
**SWITCH OPEN**, the light segment on the switch lights up.
- ⌚ ▶ Turn the switch to the  $\downarrow$  position.  
**FILTER RINSING**, water flows out of the fine foam frother.

**i** You can interrupt rinsing of the filter at any time. To do this, turn the switch clockwise. Turn the switch anticlockwise to continue rinsing the filter.

**i** The water may be slightly discoloured. This is not harmful to health and does not affect the taste.

Rinsing of the filter stops automatically after approximately 500 ml. **SWITCH CLOSE** appears on the display.

- ⌚ ▶ Turn the switch to the  $\uparrow$  position.  
**HEATING**, the machine heats up.  
**ESPRESSO** appears on the display (example).

## Cleaning the machine

After 200 preparations or 80 switch-on rinses, the IMPRESSA will prompt you to clean it.

### CAUTION

If the wrong cleaning agent is used, the machine could be damaged and/or traces could be left behind in the water.

- ▶ Use only original JURA maintenance products.

**i** The cleaning programme lasts approximately 20 minutes.

**i** Do not interrupt the cleaning programme. The quality of cleaning will be impaired if you do so.

**i** JURA cleaning tablets are available from specialised dealers.

**Precondition:** **CLEAN / ESPRESSO** is displayed (example).

- ⚠ ▶ Touch the Maintenance symbol for **approximately 2 seconds**.  
**EMPTY TRAY** appears on the display.
- ▶ Empty the drip tray and coffee grounds container and put them back into the machine.  
**PRESS RINSE**

## 5 Maintenance

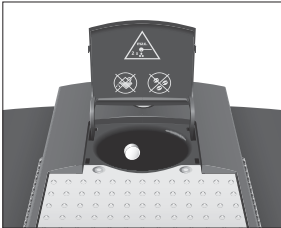

- ▶ Place a receptacle under the coffee spout.
- ⚠ ▶ Touch the Maintenance symbol.  
**CLEANING**, water flows out of the coffee spout.  
The operation is interrupted, **ADD TABLET**.
- ▶ Open the cover of the filler funnel for ground coffee.
- ▶ Insert a JURA cleaning tablet into the filler funnel.
- ▶ Close the cover of the filler funnel.
- ⚠ ▶ Touch the Maintenance symbol.  
**CLEANING**, water flows out of the coffee spout several times.  
The operation stops automatically.  
**EMPTY TRAY**
- ▶ Empty the drip tray and coffee grounds container and put them back into the machine.  
**HEATING**  
**ESPRESSO** appears on the display (example). Cleaning is now complete. Your IMPRESSA is once more ready for use.

### Descaling the machine

The IMPRESSA builds up deposits of limescale over time and automatically prompts you to descale it when necessary. The degree of calcification depends on the hardness of your water.

#### ⚠ CAUTION

If the descaling agent comes into contact with the skin or eyes, this can cause irritation.

- ▶ Avoid contact with the skin or eyes.
- ▶ Rinse off the descaling agent with clean water. Should you get any descaling agent in your eye, see a doctor.

#### CAUTION

If the wrong descaling agent is used, the machine could be damaged and/or traces could be left behind in the water.

- ▶ Use only original JURA maintenance products.

#### CAUTION

If the descaling operation is interrupted, there may be damage to the machine.

- ▶ Allow the descaling programme to run to the end.

**CAUTION** If the descaling agent comes into contact with sensitive surfaces (e.g. marble), damage cannot be ruled out.

- ▶ Clean up any splashes immediately.

- i** The descaling programme lasts approximately 45 minutes.
- i** JURA descaling tablets are available from specialised dealers.
- i** If you use a CLARIS Blue filter cartridge and this is activated, you will not be prompted to descale.

**Precondition:** **DESCALE** / **ESPRESSO** is displayed (example).

- ⚡ ▶ Touch the Maintenance symbol for **approximately 2 seconds**.

**EMPTY TRAY** appears on the display.

- ▶ Empty the drip tray and coffee grounds container and put them back into the machine.

**AGENT IN TANK**

- ▶ Remove and empty the water tank.
- ▶ Completely dissolve the contents of one blister (3 JURA descaling tablets) in a receptacle holding 500 ml of water. This may take several minutes.
- ▶ Pour the solution into the empty water tank and insert it into the machine.

**SWITCH OPEN**, the light segment on the switch lights up.

- ▶ Carefully remove the fine foam frother from the Connector System® by twisting slightly.
- ▶ Place a receptacle (at least 500 ml) under the Connector System®.



- ▶ Turn the switch to the ⚡ position.

**DESCALE**, water flows out of the Connector System® several times. The Maintenance symbol ⚡ flashes during the descaling operation.

The operation is interrupted, **SWITCH CLOSE**.



- ▶ Turn the switch to the ⚡ position.

**DESCALE**, the descaling operation is continued.

The operation is interrupted, **EMPTY TRAY**.

- ▶ Empty the drip tray and coffee grounds container and put them back into the machine.

**FILL TANK**

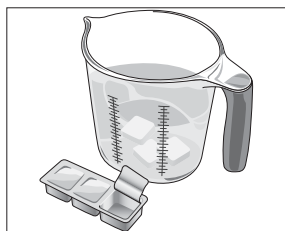



- ▶ Empty the receptacle and place it back under the Connector System®.
- ▶ Place another receptacle under the coffee spout.
- ▶ Remove the water tank and rinse it thoroughly.
- ▶ Fill the water tank with fresh, cold water and reinsert the tank.

**SWITCH OPEN**, the light segment on the switch lights up.



- ▶ Turn the switch to the  position.

**DESCALE**, the descaling operation is continued.

The operation is interrupted, **SWITCH CLOSE**.



- ▶ Turn the switch to the  position.

**DESCALE**, the descaling operation is continued.

The operation is interrupted, **DESCALE**.

Water flows out of the coffee spout.

**EMPTY TRAY**

- ▶ Re-assemble the fine foam frother.
- ▶ Empty the drip tray and coffee grounds container and put them back into the machine.

**ESPRESSO** appears on the display (example). Descaling is now complete. Your IMPRESSA is once more ready for use.



- ▶ If the descaling operation stops unexpectedly, rinse the water tank thoroughly.

## Cleaning the bean container

Coffee beans may be covered with a slight oil film which remains on the walls of the bean container. These traces may negatively affect the coffee result. For this reason clean the bean container from time to time.

**Precondition:** **FILL BEANS** is displayed.





- ▶ Switch the machine off with the On/Off button.
- ▶ Open the bean container cover and remove the aroma preservation cover.
- ▶ Clean the bean container with a soft, dry cloth.
- ▶ Fill the bean container with coffee beans and close the aroma preservation cover.
- ▶ Close the bean container cover.

**Descaling the water tank**

Limescale deposits may form in the water tank. To ensure correct function of the machine, descale the water tank from time to time.

- ▶ Remove the water tank.
- ▶ If you use a CLARIS Blue filter cartridge, remove this.
- ▶ Descale the tank with a mild conventional descaling agent in accordance with the manufacturer's instructions.
- ▶ Rinse out the water tank thoroughly.
- ▶ If you use a CLARIS Blue filter cartridge, insert this again.
- ▶ Fill the water tank with fresh, cold water and reinsert the tank.

## 6 Display messages

| Message                            | Cause/Result  | Action  |
|------------------------------------|---|---|
| FILL TANK                          | The water tank is empty. You cannot prepare any products.   | ▶ Fill the water tank (see Chapter 1 'Preparing and using for the first time – Filling the water tank').  |
| EMPTY GROUNDS                      | The coffee grounds container is full. No speciality coffees can be prepared, but hot water preparation is possible. | ▶ Empty the coffee grounds container and the drip tray (see Chapter 3 'Daily operation – Daily maintenance').   |
| TRAY MISSING                       | The drip tray is not inserted correctly or is not inserted at all. You cannot prepare any products.                 | ▶ Fit the drip tray.  |
| FILL BEANS                         | The bean container is empty. No speciality coffees can be prepared, but hot water preparation is possible.          | ▶ Fill the bean container (see Chapter 1 'Preparing and using for the first time – Filling the bean container').<br>▶ Press the Rotary Switch  to confirm that the bean container has been filled. |
| PRESS RINSE                        | The IMPRESSA is prompting you to continue a previously started maintenance programme.                               | ▶ Touch the Maintenance symbol  to continue the programme.   |
| FILTER /<br>ESPRESSO<br>(example)  | The filter cartridge no longer works.   | ▶ Replace the CLARIS Blue filter cartridge (see Chapter 5 'Maintenance – Changing the filter').   |
| CLEAN /<br>ESPRESSO<br>(example)   | The IMPRESSA is prompting you to clean it.  | ▶ Perform cleaning (see Chapter 5 'Maintenance – Cleaning the machine').  |
| DESCALE /<br>ESPRESSO<br>(example) | The IMPRESSA is prompting you to descale it.  | ▶ Perform descaling (see Chapter 5 'Maintenance – Descaling the machine').  |
| LOW FILL<br>GROUND C               | There is insufficient ground coffee in the machine; the IMPRESSA stops the operation.                               | ▶ The next time you prepare a beverage, add more ground coffee (see Chapter 2 'Preparation – Ground coffee').   |



| Message | Cause/Result  | Action  |
|---------|---|---|
| TOO HOT | The system is too hot to start a maintenance programme. | ▶ Wait for several minutes until the system has cooled or prepare a speciality coffee or hot water. |

## 7 Troubleshooting

| Problem   | Cause/Result   | Action  |
|---|--|---|
| Insufficient foam is produced when the milk is frothed or milk sprays out of the fine foam frother. | The fine foam frother is dirty.  | <ul style="list-style-type: none"> <li>▶ Clean the fine foam frother (see Chapter 5 'Maintenance – Cleaning the fine foam frother').</li> <li>▶ Dismantle and rinse the fine foam frother (see Chapter 5 'Maintenance – Dismantling and rinsing the fine foam frother').</li> </ul>         |
| Coffee only comes out in drips when it is being prepared.   | Coffee or ground coffee has been ground too finely and is blocking the system. The same filter cartridge may have been used several times or the water hardness set incorrectly in the programming mode. | <ul style="list-style-type: none"> <li>▶ Put the grinder on a coarser setting or use coarser ground coffee (see Chapter 1 'Preparing and using for the first time – Adjusting the grinder').</li> <li>▶ Perform descaling (see Chapter 5 'Maintenance – Descaling the machine').</li> </ul> |
| Water hardness cannot be adjusted.  | The CLARIS Blue filter cartridge is activated.   | <ul style="list-style-type: none"> <li>▶ Deactivate the filter cartridge in programming mode.</li> </ul>  |
| <b>FILL TANK</b> is displayed although the water tank is full.                                      | The water tank float is trapped.   | <ul style="list-style-type: none"> <li>▶ Descale the water tank (see Chapter 5 'Maintenance – Descaling the water tank').</li> </ul>  |
| Grinder is making a very loud noise.  | There are foreign objects in the grinder.  | <ul style="list-style-type: none"> <li>▶ Contact customer support in your country (see Chapter 11 'JURA contact details / Legal information').</li> </ul>   |
| <b>ERROR 2</b> or <b>ERROR 5</b> is displayed.  | If the machine has been exposed to the cold for a long period of time, heating may be disabled for safety reasons.   | <ul style="list-style-type: none"> <li>▶ Warm the machine at room temperature.</li> </ul>   |

| Problem                                    | Cause/Result | Action   |
|--|--------------|--|
| Other <b>ERROR</b> messages are displayed. | –            | Switch the machine off with the On/Off button. Contact customer support in your country (see Chapter 11 ‘JURA contact details / Legal information’). |

- i** If you were unable to solve the problem, contact customer support in your country (see Chapter 11 ‘JURA contact details / Legal information’).

## 8 Transport and environmentally friendly disposal

### Transport / Emptying the system

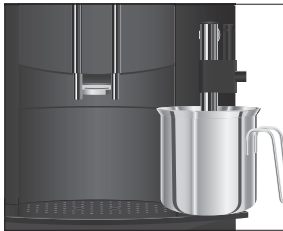

Keep the packaging for your IMPRESSA. It should be used to protect the machine during transport.

In order to protect the IMPRESSA from frost during transport, the system must be emptied.

**Precondition:** ESPRESSO is displayed (example).

- ▶ Remove the milk pipe from the fine foam frother.
- ▶ Place a receptacle under the fine foam frother.



- ▶ Touch the Steam symbol.

HEATING / STEAM

As soon as the machine has heated up, STEAM / READY appears, the light segment on the switch lights up.



- ▶ Turn the switch to the  position.

STEAM appears and hot steam is discharged from the fine foam frother.

- ▶ Remove and empty the water tank.

Steam will continue to be discharged from the fine foam frother until the system is empty.

SWITCH CLOSE



- ▶ Turn the switch to the  position.

FILL TANK



- ▶ Press the On/Off button.

Your IMPRESSA is switched off.

### Disposal

Please dispose of old machines in an environmentally neutral way.



Old machines contain valuable, recyclable materials which should be recycled. Please therefore dispose of old machines via suitable collection systems.

## 9 Technical data

|  |                     |
|--|---------------------|
| Voltage                                      | 220–240 V ~, 50 Hz  |
| Power  | 1450 W              |
| Conformity mark                              | CE <sup>®</sup>     |
| Energy consumption<br>ENERGY ✓               | Approx. 9 Wh        |
| Energy consumption<br>ENERGY –               | Approx. 15 Wh       |
| Pump pressure                                | Static, max. 15 bar |
| Holding capacity of water tank               | 1.9 l               |
| Holding capacity of bean container           | 200 g               |
| Holding capacity of coffee grounds container | Max. 16 portions    |
| Cable length                                 | Approx. 1.1 m       |
| Weight                                       | Approx. 9.6 kg      |
| Dimensions (W × H × D)                       | 28 × 34.5 × 41 cm   |

## 10 Index

### A

- Addresses 48
- Aroma preservation cover
  - Bean container with aroma preservation cover 4
- Automatic switch-off 27

### B

- Bean container
  - Bean container with aroma preservation cover 4
  - Cleaning 38
  - Filling 10
- Bus bar
  - Technical data 45
- Button
  - On/Off button 4

### C

- Cappuccino 17
- Cappuccino frother rinsing 30
- CLARIS Blue filter cartridge
  - Changing 34
  - Inserting and activating the filter 33
- Cleaning
  - Bean container 38
  - Fine foam frother 30
  - Machine 35
- Coffee 16
- Coffee grounds container 4
- Coffee spout
  - Height-adjustable coffee spout 4
- Consistency of grind
  - Adjusting the grinder 13
  - Grinder adjustment switch 4
- Contact details 48
- Cover
  - Bean container 4
  - Filler funnel for ground coffee 4
  - Water tank 4
- Cup grille 4
- Customer support 48

### D

- Descaling
  - Machine 36
  - Water tank 39

- Display 5
- Display messages 40
- Disposal 44
- Double product 17
- Drip tray 4

### E

- Emptying the system 44
- Energy-saving mode 26
- Errors
  - Troubleshooting 42
- Espresso 16

### F

- Filler funnel
  - Filler funnel for ground coffee 4
- Filling
  - Bean container 10
  - Water tank 14
- Filter
  - Changing 34
  - Inserting and activating the filter 33
- Fine foam frother 4
  - Cleaning 30
  - Dismantling and rinsing 31
  - Rinsing 30
- First-time use 10
  - With filter cartridge activation 11
  - Without filter cartridge activation 12

### G

- Grinder adjustment switch 4
- Ground coffee 19

### H

- Height-adjustable coffee spout 4
- Hotline 48
- Hot water 21
- Hot water and steam preparation
  - Switch for hot water and steam preparation 4

### I

- Instant coffee
  - Ground coffee 19
- Internet 10

### J

- JURA
  - Contact details 48
  - Internet 10

**L**

Language 28

**M**

Machine

- Cleaning 35
- Descaling 36
- Rinsing 29
- Setting up 10
- Switching off 23
- Switching on 22

Mains cable 4

Maintenance 29

- Daily maintenance 22

Messages, display 40

Milk

- Connecting milk 15

Milk foam 18

**P**

Permanently setting the water for the cup size 20

Permanent settings in programming mode 24

Preparation 16

- Cappuccino 17
- Coffee 16
- Espresso 16
- Ground coffee 19
- Hot water 21
- Milk foam 18
- Two speciality coffees 17

Problems

- Troubleshooting 42

Product settings 25

Professional fine foam frother

- Dismantling and rinsing 32

Programming mode 24

- Automatic switch-off 27
- Energy-saving mode 26
- Language 28
- Product settings 25
- Setting the water hardness 26
- Unit for amount of water 28

Proper use 6

**R**

Rinses

- Cappuccino frother rinsing 30

Rinsing

- Fine foam frother 30
- Machine 29

Rotary Switch 5

**S**

Safety 6

Safety information 6

Settings

- Permanent settings in programming mode 24

Setting up

- Setting up the machine 10

Short operating instructions 10

Switch for hot water and steam preparation 4

Switching off

- Machine 23

Switching on

- Machine 22

Switch-off

- Automatic switch-off 27

Symbol

- Maintenance 5
- P (programming) 5
- Steam 5

Symbol description 3

**T**

Technical data 45

Tel 48

Transport 44

Troubleshooting 42

Two products 17

**U**

Unit for amount of water 28

Use, First-time 10

**W**

Water hardness

- Determining the water hardness 13
- Setting the water hardness 26

Water tank 4

- Descaling 39

- Filling 14

Website 10

## 11 JURA contact details / Legal information

JURA Elektroapparate AG  
Kaffeeweltstrasse 10  
CH-4626 Niederbuchsiten  
Tel. +41 (0)62 38 98 233

@ You will find additional contact details for your country at  
**[www.jura.com](http://www.jura.com)**.

- Directives** The machine complies with the following directives:
- 2014/35/EU – Low Voltage Directive
  - 2014/30/EU – Electromagnetic Compatibility
  - 2009/125/EC – Ecodesign Directive
  - 2011/65/EU – RoHS Directive

**Technical changes** We reserve the right to make technical changes. The diagrams used in these instructions for use are for illustration purposes only and do not represent the original colours of the machine. Some details of your IMPRESSA may vary.

**Feedback** Your opinion is important to us! Use the contact details at [www.jura.com](http://www.jura.com).

**Copyright** The instructions for use contain information which is protected by copyright. It is not permitted to photocopy these instructions for use or translate them into another language without the prior written consent of JURA Elektroapparate AG.